

wiring channels

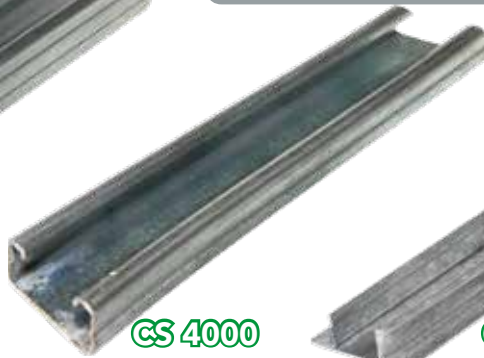

Product Code	Thickness	Mss kg/m	Standard Length	Dimensions
CS 1000	2.5mm	3.0	5m	41 x 41mm
CS 3300	2.5mm	1.8	6m	41 x 21mm
CS 2000	1.5mm	1.0	5m	41 x 41mm
CS 4000	1.6mm	1.3	5m	41 x 21mm
CS 1184	0.6mm	0.5	2.5m	

Ex-stock channels are finished galvanised | Ex-stock covers are finished Galvanised and PVC (white or grey)

technical measurements

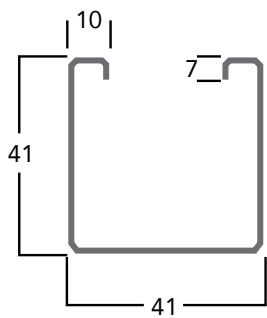

CS 1000

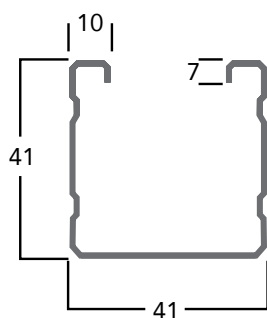

CS 2000

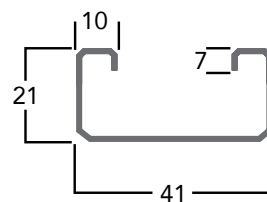

CS 3300

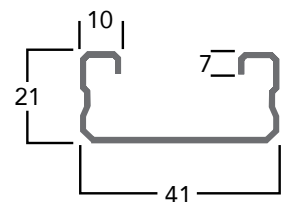

CS 4000

channel accessories

solid accessories



Internal Elbow



External Elbow



Horizontal Elbow



Internal Splice



End Cap

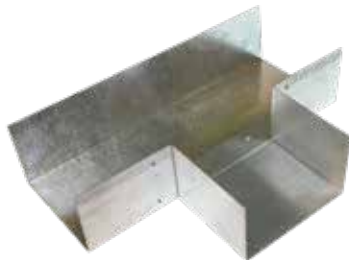

3 Way Tee



4 Way Crossover



Hanger



Flange Hanger



Purlin Hanger



Brass Fluorescent Adaptor - 20mm



Nylon Fluorescent Adaptor - 20mm

trunking & covers

Product Code	Thickness	Mss kg/m	Standard Length	Dimensions
CS 8000	0.6mm	1.2	3m	76 x 76mm
CS 8300	0.8mm	1.4	3m	76 x 63mm
CS 8200	0.8mm	0.95	3m	76 x 50mm
CS 8184	0.6mm	0.6	3m	
CS 9000	0.8mm	1.9	3m	127 x 76mm
CS 9184	0.6mm	0.82	3m	
CS 2200	0.8mm	1.0	3m	50 x 50mm
CS 2184	0.8mm	0.5	3m	

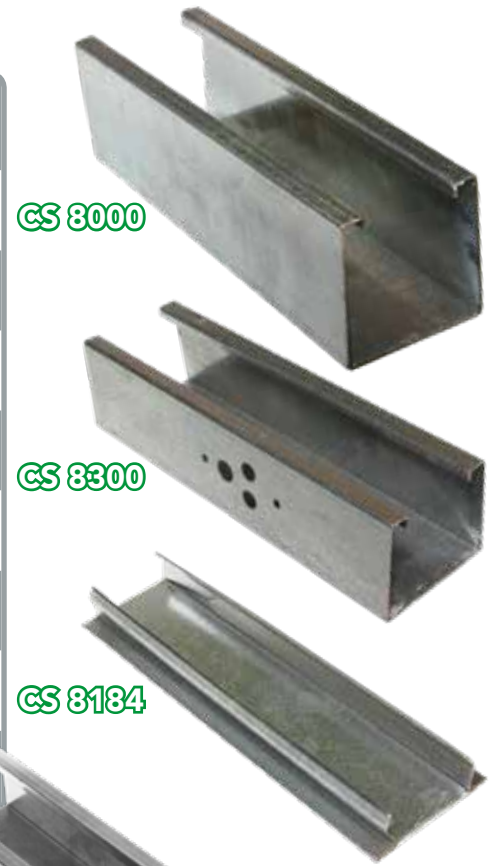

CS 8000

CS 8300

CS 8184



CS 2200

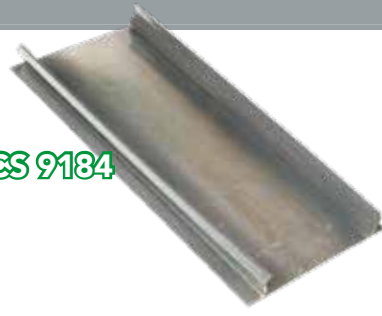

CS 9184

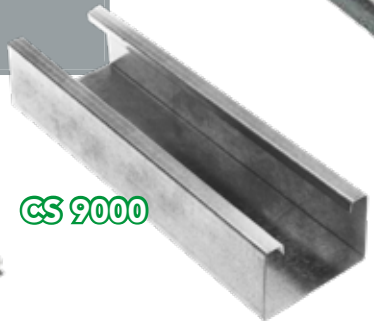

CS 9000

For **CS 8300 trunking**, the knockouts fit 3 pin 5 amp plug sockets. Knockouts are placed at 750mm centres, staggered



CS 8200

For **CS 2200 trunking**, the 20mm knockouts are spaced at 152mm centres, staggered.



CS 2200 with cover

Ex-stock trunking is finished galvanised | Ex-stock covers are finished Galvanised and PVC (white or grey)

pvc trunking

compact miniature trucking



YT1



YT2



YT3



YT4



YT5

Product Code	Dimensions	Standard Length
YT 1	16 x 16mm	2m
YT 2	25 x 16mm	3m
YT 3	40 x 16mm	3m
YT 4	40 x 25mm	3m
YT 5	40 x 40mm	3m

We have a full range of accessories available, to ensure a professional finish

technical measurements

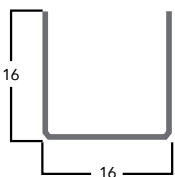

YT 1

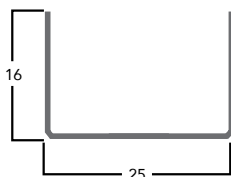

YT 2



YT 3



YT 4

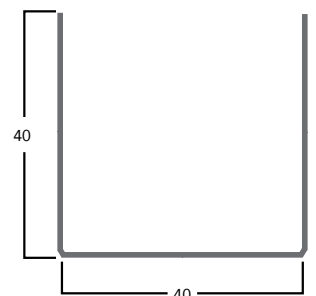

YT 5

pvc trunking

Product Code	Dimensions	Standard Length
NBT / 4	100 x 40mm	3m
NBT 4 TC	100 x 40mm	3m
Corner Trunking	55 x 30mm	3m



Corner Trunking



NBT / 4
Single Compartment



NBT / 4 / TC
Twin Compartment

half moon trunking



2 Compartment



3 Compartment



4 Compartment

technical measurements

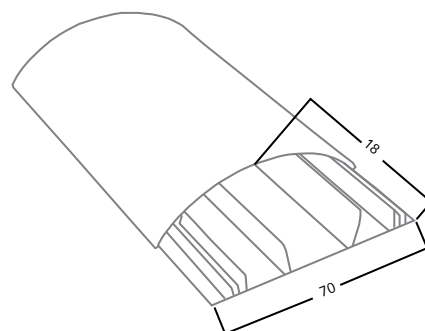
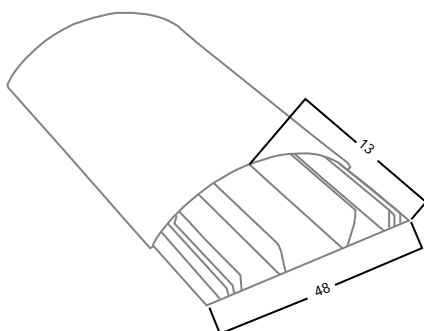

pvc trunking

industrial cable trunking

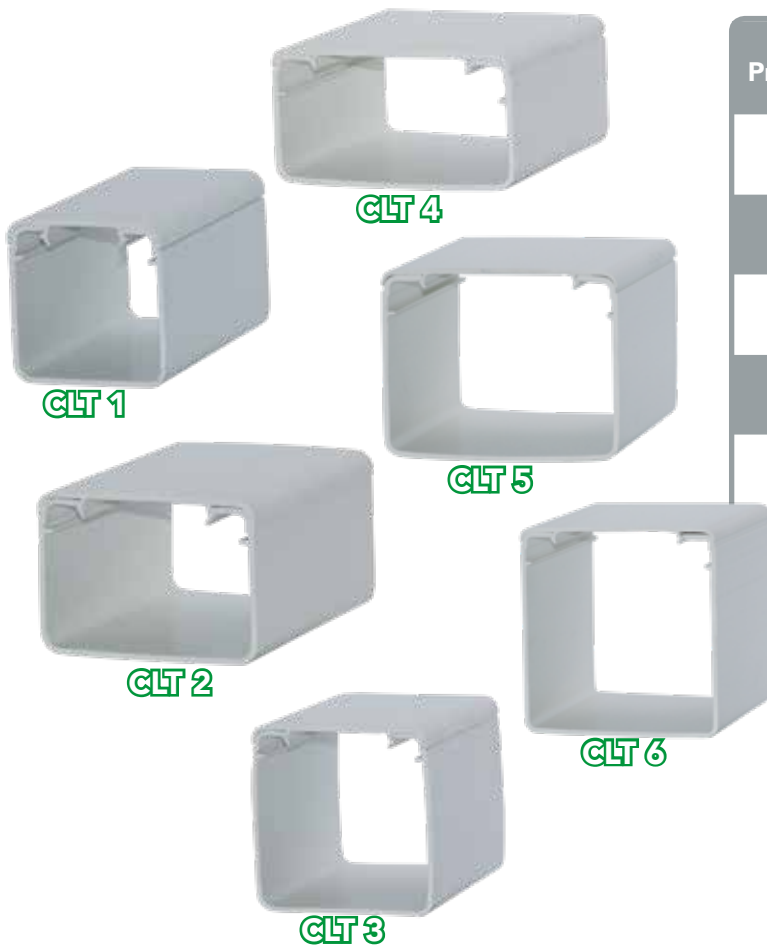

Product Code	Dimensions	Standard Length
CLT 1	50 x 50mm	3m
CLT 2	75 x 50mm	3m
CLT 3	75 x 75mm	3m
CLT 4	100 x 50mm	3m
CLT 5	100 x 75mm	3m
CLT 6	100 x 100mm	3m

All in grey
Available in white on request

technical measurements

